























# We power the world with innovative gas engines

Guascor Energy gas engine portfolio

# Gas engines from 209 to 2,065 kWb

## 50 Hz or 60 Hz

SGE-100EM		2,065	2,065 kW
SGE-86EM		2,065	2,065 kW
SGE-56HM		1,040	1,350 kW
SGE-42HM		1,040	1,040 kW
SGE-24HM		520	520 kW
SGE-56SR		660	870 kW
SGE-48SR		510	840 kW
SGE-36SR		440	660 kW
SGE-24SR		255	420 kW
SGE-18SR		220	330 kW
SGE-56SM		1,030	1,100 kW
SGE-48SM		725	906 kW
SGE-36SM		550	700 kW
SGE-24SM		360	453 kW
SGE-18SM		275	350 kW
SGE-56SL		560	1,150 kW
SGE-48SL		561	1,060 kW
SGE-36SL		418	790 kW
SGE-24SL		281	530 kW
SGE-18SL		209	350 kW

The Guascor Energy gas engine range has been designed and tailored to help meet our customers' challenges in a dynamic market environment.

Our models range from 190 to 2,065 kW, fulfilling the requirements of wide spectrum of applications in terms of efficiency, reliability, flexibility, and environmental compatibility.

The products offer low lifecycle costs and an excellent return of investment.

- Data referred to thermal balances published at 20th November 2020

- Mechanical power of the SL Series includes Standby and Prime app







# Table of contents

best-in-class, high-efficiency, low-emission gas engines and gensets are designed for various applications such as power generation, cogeneration, and waste to energy. These engines are suitable for a broad range of commercial, industrial and municipal uses with long service intervals, easy maintenance and low fuel consumption.

<b>01</b>	<b>S Series gas engines</b> Page 07
<b>02</b>	<b>H Series gas engines</b> Page 21
<b>03</b>	<b>E Series gas engines</b> Page 27
<b>04</b>	<b>Containers</b> Page 32
<b>05</b>	<b>Performance data overview</b> Page 34





We power the world with innovative gas engines

# SL- Gas engines:

A robust, reliable and fuel flexible power generation

- Mechanical power output: from 209 kWb to 1,150 kWb (1,200, 1,500 and 1,800 rpm)
- Powered by natural gas, landfill and sewage gas, flare and well gas, syngas
- Proven reliable and robust design
- Fast start availability
- Fuel flexibility
- Fuel blending availability
- Eco friendly
- Cost efficient implementation and service
- Load acceptance great flexibility
- Best in class global efficiency

## SL gas engines

- SGE-18SL
- SGE-24SL
- SGE-36SL
- SGE-48SL
- SGE-56SL









We power the world with innovative gas engines

# SGE-SL

## Gas engines

The SL gas engines offer systems for a large variety of applications as Cogeneration/trigeneration, Sewage/landfills/biogas processes for utilities and public buildings, and different kind of industries: textile, cement, food processing,... as well as greenhouses.

Also is able to operate with a low quality gases, flare gas and syngas from a gasification process.

containerized CHP biogas genset solution for Johannesburg Water, South Africa.



### Applications

- Power generation (cont, LTP, ESP, PRP,...)
- CHP and Trigeneration
- Waste to power
- Marine applications
- Mechanical drive (for pump driving)

### References

- Universities
- Wesleyan (USA)
- Wolverhampton (UK)
- Utilities (Landfill, sewage plants)
- ETE (Brazil)
- Johannesburg (South Africa)
- Fypasa (Mexico)
- Storms Hog (USA)



We power the world with innovative gas engines

- Fuel blending system available for biogas gensets
- Integrated proprietary GCS-E engine and GCS-G genset control systems
- High flexibility through modularity

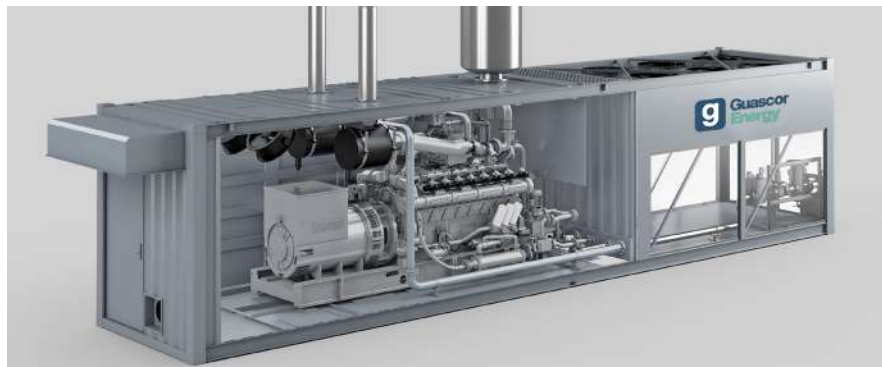

SGE-56 SL containerized genset for Cogeneration



SGE-48SL Gas Genset.

**Power generation - CHP**

<b>Power output</b>	241 to 1058 kWe (natural gas)
<b>Fuel</b>	Natural gas, biogas, landfill gas, sewage gas, flare gas, well gas, syngas
<b>Frequency</b>	50 and 60 Hz
<b>Speed</b>	1,200 / 1,500 / 1,800 rpm
<b>Electric efficiency</b>	36 - 39,8 %
<b>Thermal efficiency</b>	51 - 55 %
<b>Total efficiency</b>	90 - 91.5 %
<b>NOx emissions</b>	500 mg / Nm3

(\*) Lower emission engines are available.

**Best-in-class global efficiencies for CHP in Natural gas S Series: 500 1,030 kWe**

**Physical dimensions**

<b>Approximate weight (genset)</b>	4,000 to 10,000 kg
<b>Length</b>	2.8 - 4.3 m
<b>Frequency</b>	1.5 - 1.7 m
<b>Height</b>	2.1 - 2.3 m

- Lean burn, turbocharged and aftercooled
  - Electronically carbureted
  - Fuel blending capability (natural gas/biogas) available
  - Single or double circuit cooling system
  - High cooling temperature option in main circuit 120°C
  - Different auxiliary cooling circuit temperatures
  - Oil cooler in main circuit option available
  - Dry/wet exhaust manifold
  - Single/double stage intercooler
  - Reduced oil consumption
  - Emissions control
  - Compliant with the U.S. emissions standards
  - Fast start availability
- Supplied as a stand-alone engine, genset or in a fully containerized unit



We power the world with innovative gas engines

# SGE-SL

## Marine gas engines

The complete family of SGE-SL gen-sets with a variety of applications such as Auxiliary power generation and electrical propulsion - constant speed.

### Applications

For a large variety of vessels: tugboats, tankers, ferries, oceanographic, special vessels and others

- Auxiliary power generation
- Electrical propulsion



A gas fueled vessel.



We power the world with innovative gas engines

- Working speeds: 1,500 & 1,800 rpm
- Emissions compliant IMO TIER III.



SGE-56 SL marine gas engine.



Containerized 56SL genset for harbour use.

**Power generation**

<b>Power output*</b>	320 - 1110 KVA (256-888 kWe)
<b>Fuel</b>	LNG. Methane number from 70
<b>Frequency</b>	50 and 60 Hz
<b>Speed</b>	1,500 / 1,800 rpm

**Physical dimensions**

<b>Approximate weight (genset)</b>	320 - 1110 KVA (256-888 kWe)
<b>Length</b>	LNG. Methane number from 70
<b>Width</b>	50 and 60 Hz
<b>Height</b>	1,500 / 1,800 rpm

- Working speeds: 1,500 and 1,800 rpm
- Fuel: LNG (Liquefied Natural Gas). Methane number from 70
- Cooling configurations: With mechanical and electrical water pumps
- Water circuits T°: 90/40 °C

(\* ) Based on existing gas engines power ratings for the ambient conditions required in the marine market.

Note 1) For a large variety of vessels as tugboats, tankers, ferries, oceanographic, special vessels.



We power the world with innovative gas engines

# SR- Gas engines:

Designed for rich burn power generation

- Mechanical power output: from 220 kW to 870 kWb (1,800 rpm) • Powered by natural gas
- Robust design
- Eco friendly
- Load acceptance great flexibility

## SR gas engines

- SGE-18SR
- SGE-24SR
- SGE-36SR
- SGE-48SR
- SGE-56SR







We power the world with innovative gas engines

# SGE-SR

## SR Engines

This engine is spark ignited and powered by natural gas and well gas. Robust and reliable, has great flexibility for load acceptance and great performance for power generation and cogeneration.

### Applications

- Power Generation
- Cogeneration



LNGo micro-scale natural gas liquefaction system.

We power the world with innovative gas engines

- Only suitable for 60 Hz markets (USA)
- Part of the LNGo solution package



LNGo Power modules (SL), Altagas Ltd. British Columbia, Canada.

Power generation - CHP	
Power output*	273 to 844 kW <sub>e</sub>
Fuel	Natural gas, Well gas
Frequency	60 Hz
Speed	1,800 rpm
Electric efficiency	33 - 34 %

Physical dimensions	
Approximate weight (genset)	4,000 to 10,000 kg
Length	2.8 - 4.3 m
Width	1.5 - 1.7 m
Height	2.1 - 2.3 m

- Rich burn
- Turbocharged and aftercooled
- Wet Exhaust Manifold
- Electronically carbureted
- Powered by natural gas and well gas
- Double circuit cooling system
- Different auxiliary cooling circuit temperatures
- Single/double stage intercooler
- Great flexibility for load acceptance
- Emissions control
- Compliant with the U.S. emissions standards



# SM- Gas engines:

Designed for fuel flexible power generation

- Mechanical power output: from 1,055 to 1,100 kWb when powered by natural gas, landfill, and sewage gas (1,500 and 1,800 rpm)
- Mechanical power output from 275 to 1067 kWb when powered by propane LPG (1,500 and 1,800 rpm)
- Powered by natural gas, landfill, sewage gas and propane
- High efficiency
- Load acceptance great flexibility
- High quick start and operational availability
- Standard interchangeable parts

## SM gas engines

- SGE-18SM
- SGE-24SM
- SGE-36SM
- SGE-48SM
- SGE-56SM







We power the world with innovative gas engines

# SGE-SM

## Gas engines

The SM gas engine offers systems for a large variety of applications such as Cogeneration/trigeneration.

The SM gas engine is also able to operate with other types of gases like propane or biogases.

Applications	References				
<ul style="list-style-type: none"><li>• Power generation</li><li>• CHP and Trigenration</li><li>• Waste to power</li></ul>	<table><thead><tr><th>SGE-24SM</th><th>SGE-56SM</th></tr></thead><tbody><tr><td><ul style="list-style-type: none"><li>• Puerto Rico (propane), Food industry</li><li>• Trigenration</li></ul></td><td><ul style="list-style-type: none"><li>• Anaerobic digestion from POME and animal manure in Thailand and Indonesia</li></ul></td></tr></tbody></table>	SGE-24SM	SGE-56SM	<ul style="list-style-type: none"><li>• Puerto Rico (propane), Food industry</li><li>• Trigenration</li></ul>	<ul style="list-style-type: none"><li>• Anaerobic digestion from POME and animal manure in Thailand and Indonesia</li></ul>
SGE-24SM	SGE-56SM				
<ul style="list-style-type: none"><li>• Puerto Rico (propane), Food industry</li><li>• Trigenration</li></ul>	<ul style="list-style-type: none"><li>• Anaerobic digestion from POME and animal manure in Thailand and Indonesia</li></ul>				



Olein food industry plant, two containerized SGE-24SM engines.

- Great flexibility for running with fuels as propane
- Integrated proprietary GCS-E engine and GCS-G genset control systems
- High flexibility through modularity



48SM Engine.



A CHP package of SM genset.

- Lean burn, turbocharged and aftercooled
- Miller cycle
- Electronically carburated
- Double circuit cooling system
- Different auxiliary cooling circuit temperatures
- Oil cooler in main circuit option available
- Dry/Wet exhaust manifold
- Single/double stage intercooler
- Reduced oil consumption
- Emissions control
- Compliant with the U.S. emissions standards

Power generation - CHP	
<b>Power output*</b>	275 to 1030 kWe (Propane (LPG))
<b>Fuel</b>	Propane
<b>Frequency</b>	50 and 60 Hz
<b>Speed</b>	1,500 / 1,800 rpm
<b>Electric efficiency</b>	36 - 36.3 %
<b>Thermal efficiency</b>	53 - 55 %
<b>Total efficiency</b>	91 - 93 %
<b>NOx emissions</b>	500 mg / Nm3

Power generation	
<b>Power output*</b>	1,025 to 1,060 kWe
<b>Fuel</b>	Natural gas, biogas
<b>Frequency</b>	50 and 60 Hz
<b>Speed</b>	1,500 / 1,800 rpm
<b>Electric efficiency</b>	39 - 41 %
<b>Thermal efficiency</b>	51 - 52 %
<b>Total efficiency</b>	92 %
<b>NOx emissions</b>	500 mg / Nm3

Physical dimensions	
<b>Approximate weight (genset)</b>	4,000 to 10,000 kg
<b>Length</b>	2.8 - 4.3 m
<b>Width</b>	1.5 - 1.7 m
<b>Height</b>	2.1 - 2.3 m

Supplied as a stand-alone engine, genset or in a fully containerized unit



We power the world with innovative gas engines

# HM- Gas engines:

Designed for high performance power generation

- Mechanical power output: from 520 to 1,350 kWb (1,200, 1,500 and 1,800 rpm)
- Powered by natural gas, sewage gas and landfill gas
- Fuel flexibility and fuel blending availability
- High performance
- Low life cycle cost
- Cost efficient
- Compact solution
- Best-in-class electrical efficiencies in biogas and natural gas

## HM gas engines

- SGE-24HM
- SGE-42HM
- SGE-56HM







We power the world with innovative gas engines

# SGE-HM

## Gas engines

The proven HM engine series offers a robust design with Miller cycle.

This is the first reference of the 42HM model engine recently released.

A cost efficient compact solution for power generation and cogeneration processes.

### Applications

- Power generation (50 Hz and 60 Hz)
- CHP - cogeneration

### References

- Sokołowie Podlaskim - Poland
- Supply two genset SGE-42HM
  - Power output - 2 MWe
- Customer; SOKOŁÓW SA



Condensation plant - Sokołowie Podlaskim - Poland.

We power the world with innovative gas engines

- Proven design
- High thermal efficiency
- Integrated proprietary GCS-E engine and GCS-G genset control systems

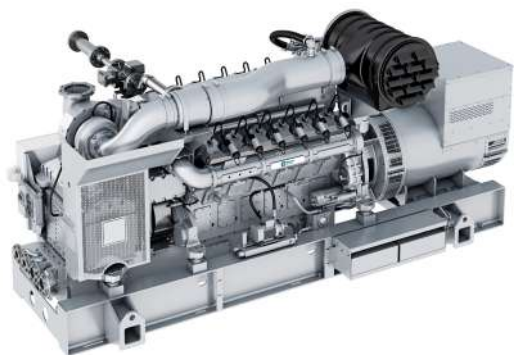

SGE-42HM genset.

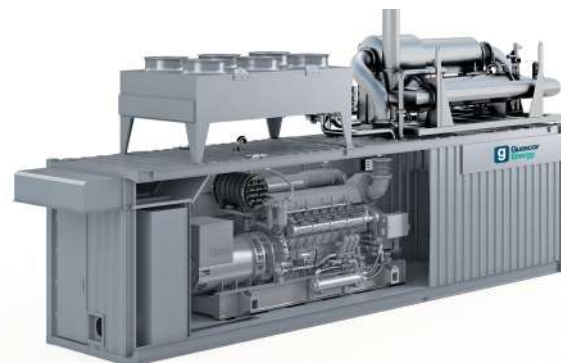

SGE-56HM containerized genset.

Power generation - CHP	
Power output*	502 to 1,315 kW
Fuel	Natural gas, biogas
Frequency	50 and 60 Hz
Speed	1,200 / 1,500 / 1,800 rpm
Electric efficiency	41 - 43 %
Thermal efficiency	47 - 49 %
Total efficiency	89 - 91 %
NOx emissions	500 mg / Nm <sup>3</sup>

**Best-in-class electrical efficiencies in Biogas (W2P) engines, H Series: 24HM: 500 kW; 42HM: 1,000 kW; 56HM: 1,300 kW**

**Best-in-class electrical efficiencies in Natural gas H Series: 24HM: 500 kW; 56HM: 1,300 kW**

Physical dimensions	
Approximate weight	6,200 to 11,000 kg
Length	4.0 - 5.6 m
Width	1.8 - 1.9 m
Height	1.7 - 2.3 m

- Miller cycle
- High efficiency
- Turbocharged and aftercooled
- Dry exhaust manifold
- Electronically carbureted
- Fuel blending capability natural gas/biogas available
- Oil cooler in main circuit option available
- Single/double stage intercooler
- Reduced oil consumption
- Emissions control

Supplied as a stand-alone engine, genset or in a fully containerized unit



## HM: Key features

### CONTROL SYSTEM

- Proprietary, fully integrated, engine control system for optimized performance and diagnosis

### LUBRICATION SYSTEM

- O/C in HT or LT circuit  
Internal oil pump
- Centrifugal oil filter for W2P applications

### POWER TRAIN

- High swirl pistons optimized for high efficiency
- Rings designed for optimized oil consumption

### INTAKE & EXHAUST SYSTEMS

- One high-efficiency turbocharger, water cooled
- Two-stage, on engine integrated, charge cooler
- Two intake manifolds outside the engine. Dry exhaust manifolds, inside the engine

### COMBUSTION SYSTEM

- Two camshafts, Miller cycle
- Cylinder head designed for maximum volumetric efficiency with water-cooled exhaust valve seats
- Pre-chamber sparkplugs

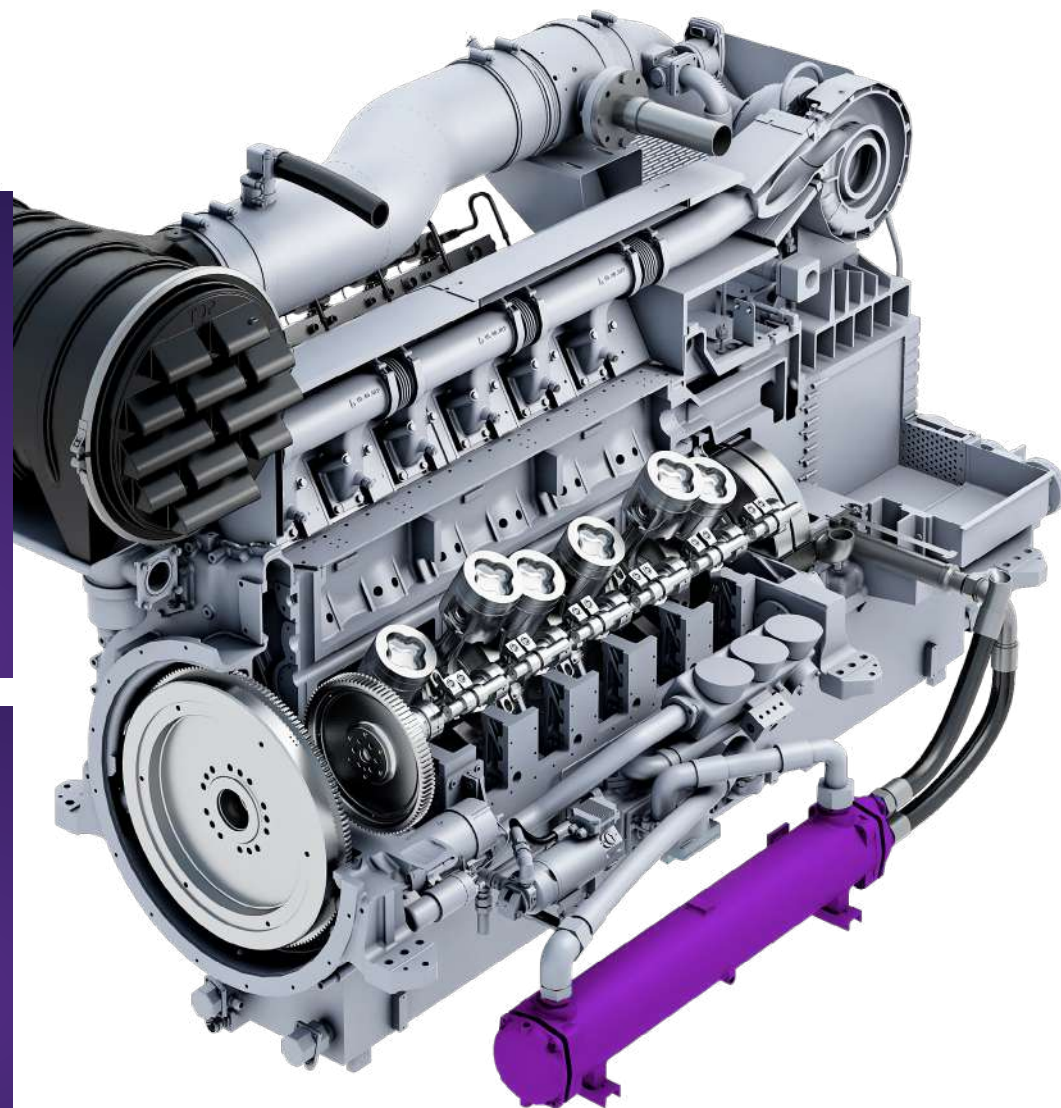





We power the world with innovative gas engines

# EM- Gas engines:

Designed for Best-in-class power generation

- Mechanical power output: 2,065 kWb (1,200 and 1,500 rpm)
- Direct Drive in 60 Hz (1,200 rpm) option
- Powered by natural gas
- Best-in-class, excellent efficiency in small footprint
- Lowest emissions
- High operational availability
- Low life cycle cost

## EM gas engines

- SGE-86EM
- SGE-100EM







We power the world with innovative gas engines

# SGE-EM

## Gas engines

The EM gas engines are the most compact competitive choice with the ability to deliver high power output with even 200 mg/Nm<sup>3</sup> NO<sub>x</sub> emissions level.



### Applications

- Power generation (50 Hz and 60 Hz)
- CHP - cogeneration

We power the world with innovative gas engines

- Highest efficiency in its class
- Lower emissions
- Lower footprint
- Best power/performance ratio
- Direct Drive for 60 Hz (1,200 rpm) option
- Lower OPEX

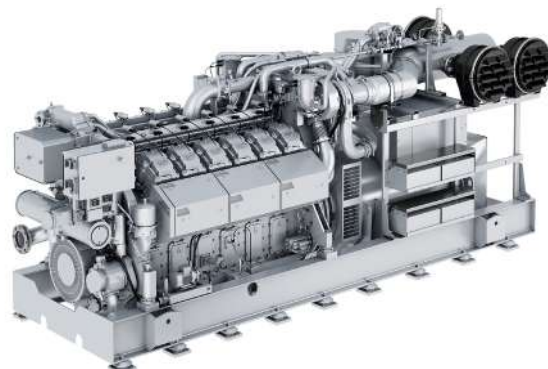

SGE-86EM genset.



Internal section of the SGE-86EM engine.

Power generation - CHP	
Power output*	2,012 kWe
Fuel	Natural gas
Frequency	50 and 60 Hz
Speed	1,200 /1,500 rpm
Electric efficiency	45.4 %
Thermal efficiency	41 %
Total efficiency	86.4 %
NOx emissions	500 mg / Nm3 NOx

## Best-in-class electrical efficiency in Natural gas E Series: 86 EM: - 2,000 kWe

Physical dimensions	
Approximate weight	14,515 kg
Length	6.4 m
Width	2.0 m
Height	2.3 m

- Miller cycle
- High efficiency turbocharger
- Dry exhaust manifold
- Electronically carburated
- New piston design for best performance
- Two circuit cooling systems
- Auxiliary cooling circuit variable temperature new concept.
- Oil cooler in main circuit
- Direct Drive for 60 Hz (1,200 rpm) option
- 90,000 hours for major overhaul
- Double stage intercooler
- Reduced oil consumption
- Emissions control

Supplied as a stand-alone engine, genset or in a fully containerized unit

Note 1) Also available at 200 mg/Nm3 NOx.



## EM: Key features

### LUBRICATION SYSTEM

- On engine integrated O/C (HT water circuit)
- External, accessible, oil pump
- Centrifugal oil filter

### CONTROL SYSTEM

- Proprietary, fully integrated, engine control system for optimized performance and diagnosis

### COMBUSTION SYSTEM

- One single camshaft, Miller cycle
- Cylinder head designed for maximum volumetric efficiency with water-cooled exhaust valve seats
- Pre-combustion chamber with direct gas injection optimized for high efficiency and low emissions

### INTAKE & EXHAUST SYSTEMS

- Two high-efficiency turbocharger, water cooled, with two bypass valves
- Two-stage, on engine integrated, charge cooler
- One intake manifold inside the engine
- Dry exhaust manifolds, outside the engine

### POWER TRAIN

- Forged steel piston for high peak combustion pressures
- Rings designed for optimized consumption
- Low mass and high resistance connecting rod

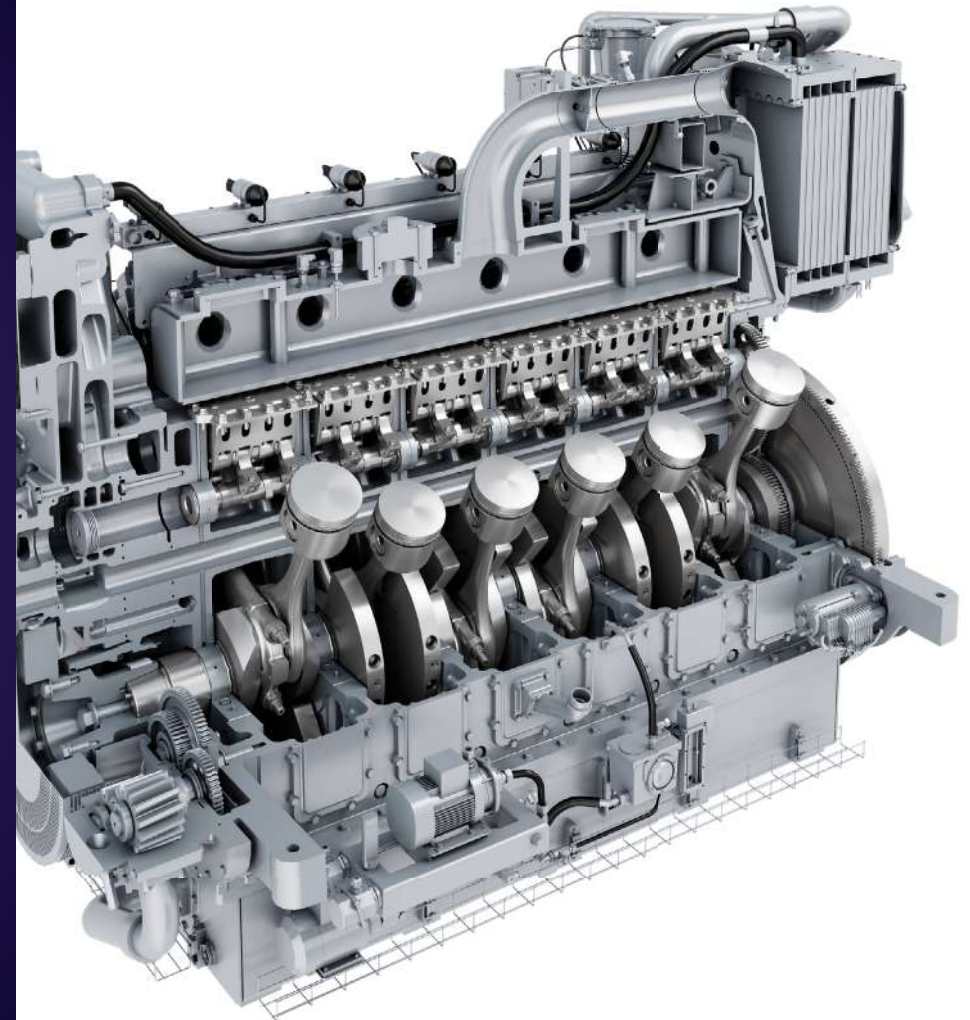





CE 2015  
N° 104454 P10.GRU.15  
GH  
www.gisa.com

500 kg



## Container models

Container type	40 feet container with embedded aircooler	40 feet container with top mounted aircooler	30 feet container with remote radiator	Soundproof canopy
<b>Brief description</b>	<p>The container is comprised of following individual areas:</p> <p>Engine room is the base module containing the genset, cooling pumps, thermostatic valves and daily oil tank.</p> <p>Cabinet room containing the electrical, control and power panels.</p> <p>Aircooler room containing the cooling system and gas ramp. When necessary also will include the heat recovery skid.</p> <p>Top mounted area- containing the exhaust silencer, chimney and if necessary the exhaust heat recovery. (for local assembly) (*) External use</p>	<p>The container is comprised of following individual areas:</p> <p>Engine room is the base module containing the genset, cooling pumps, thermostatic valves and daily oil tank. Also a heat water recovery skid can be included if necessary.</p> <p>Cabinet room containing the electrical, control and power panels.</p> <p>Top mounted area containing the exhaust silencer, chimney and the genset cooling system. If necessary also will include the exhaust heat recovery skid. (for local assembly) (*) External use</p>	<p>The container is comprised of following individual areas:</p> <p>Engine room is the base module containing the genset, cooling pumps, thermostatic valves and daily oil tank.</p> <p>Cabinet room containing control and power panels.</p> <p>The gas ramp will be installed on foot of it in one side.</p> <p>The cooling system, aircooler and exhaust silencer will be installed outside the container. Indoor use.</p>	<p>The container is comprised of a common bedframe that includes:</p> <p>The genset, pumps, thermostatic valves, plate heat exchanger, expansion vessels, exhaust recovery system, oil tank and control and power panels.</p> <p>The exhaust silencer will be installed on the roof and the aircooler outside in a remote area. (*) External use</p>
<b>Sound pressure level</b>	Down to 75 dB (A) in 10m except for the 56SL T30 model with 75 dB (A) in 1 m	Down to 75 dB (A) in 10m except for the 56SL T30 model with 75 dB (A) in 1 m	Down to 75 dB (A) in 1 m	Down to 75 dB (A) in 1 m
<b>Ambient temperatures (*)</b>	The container is designed for ambient temperatures of -18°C to 35°C with an option to reach up to 45°C	The container is designed for ambient temperatures of -18°C to 45°C	The container is designed for ambient temperatures of -10°C to 29.5°C	The container is designed for ambient temperatures of 0°C to 35°C
<b>Dimensions</b>	Length:12,192 mm; Width: 2,438 mm; Height: 2,896 mm	Length:12,192 mm; Width: 2,438 mm; Height: 2,896 mm	Length:9,144 mm; Width: 2,438 mm; Height: 2,896 mm	Length:6,000 mm; Width: 2,000 mm; Height: 3,100 mm
<b>Applications by engine models</b>	<p>Power generation: S Series including 56SLT30. H Series Line engine.</p> <p>Cogeneration: All engines except for V engines of the H Series and 56 lite engines (SL, SM)</p>	<p>Power generation: H Series except for 24 HM, SM gas propane.</p> <p>Cogeneration: H Series except for 24HM, SM gas propane and 56 liter engines</p>	Fast start: 56SL T30 engine	Power Generation, Cogeneration for all L engines

## Container: Key features

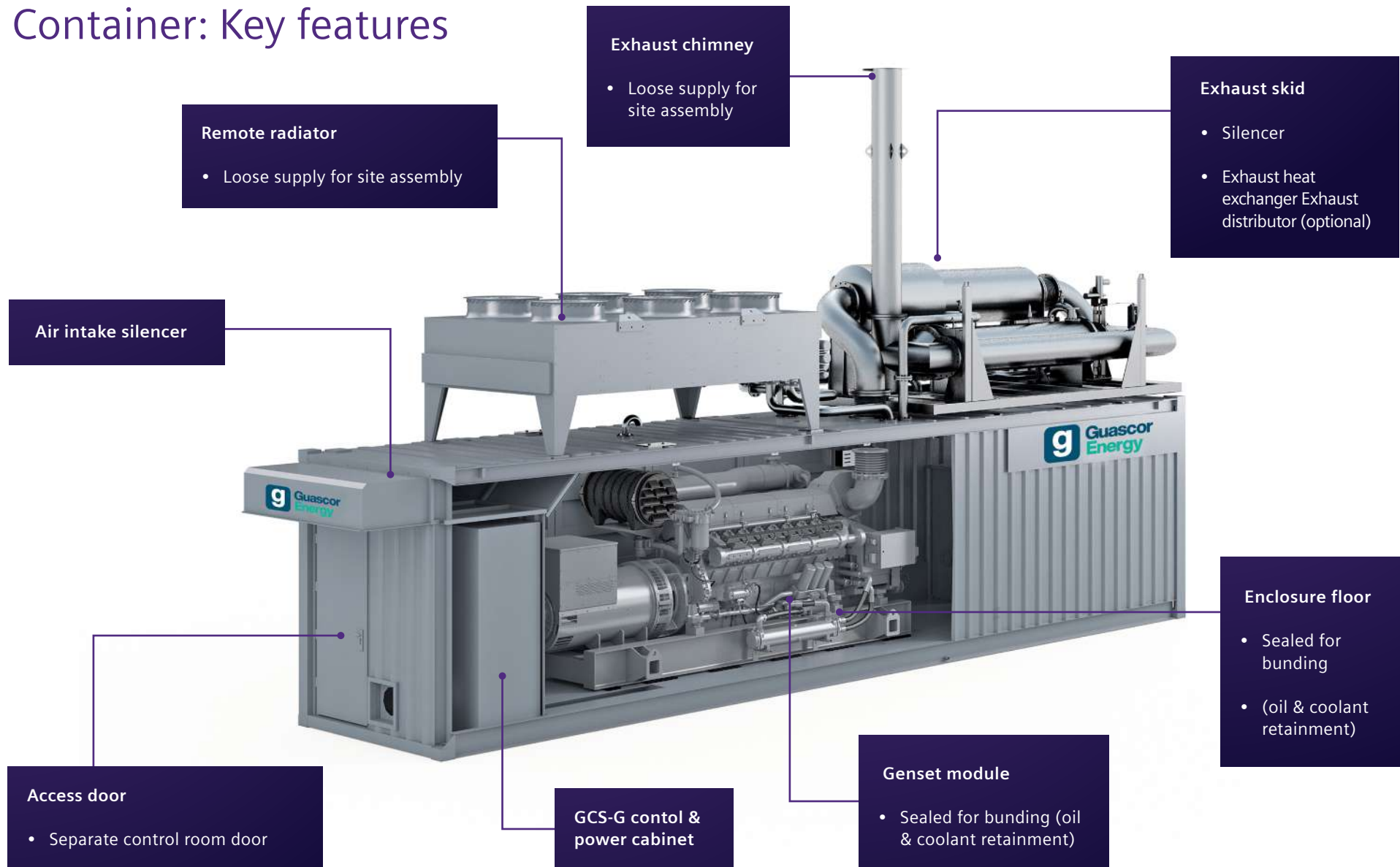



## Performance data overview

Engine Model	Speed (rpm)	Fuel type	Electrical Power (kW)	Electrical Eff. (%)	Thermal Power (kW)	Thermal Eff. (%)	Global Eff. (%)	Engine Dimensions [L x W x H] (m)	Engine Dry Weight (kg)	Genset Dimensions [L x W x H] (m)	Genset Dry Weight [kg]
SGE-18SL	1,200	Natural gas	241	38.6	320	51.3	89.9	2.0 x 0.95 x 1.46	2,700	3.02 x 1.2 x 1.85	4,000
SGE-24SL		Natural gas	322	36.1	485	54.6	90.7	2.61 x 0.95 x 1.46	3,500	3.66 x 1.27 x 1.91	4,940
SGE-36SL		Natural gas	484	38.6	656	52.2	90.8	2.64 x 1.37 x 1.74	4,200	3.83 x 1.66 x 2.13	7,230
SGE-48SL		Natural gas	648	37.7	980	55.1	92.8	3.14 x 1.37 x 1.74	5,450	4.4 x 1.66 x 2.18	9,225
SGE-56SL		Natural gas	762	39.0	1,013	51.8	90.8	3.0 x 1.55 x 2.2	5,800	4.67 x 1.66 x 2.18	10,000
SGE-18SL	1,500	Natural gas	303	39.1	396	51.0	90.1	2.0 x 0.95 x 1.46	2,700	3.02 x 1.2 x 1.85	4,000
SGE-24SL		Natural gas	404	38.5	546	51.9	90.4	2.61 x 0.95 x 1.46	3,500	3.66 x 1.27 x 1.91	4,940
SGE-36SL		Natural gas	610	38.9	810	51.7	90.6	2.64 x 1.37 x 1.74	4,200	3.83 x 1.66 x 2.13	7,230
SGE-48SL		Natural gas	811	38.8	1,093	52.2	91.0	3.14 x 1.37 x 1.74	5,450	4.4 x 1.66 x 2.18	9,225
SGE-56SL		Natural gas	954	39.0	1,280	52.2	91.2	3.0 x 1.55 x 2.2	5,800	4.67 x 1.66 x 2.18	10,000
SGE-56SL T30		Natural gas	1,058	39.8	1,379	51.8	91.6	3.0 x 1.55 x 2.2	5,800	4.67 x 1.66 x 2.18	10,000
SGE-18SL	1,800	Natural gas	336	37.4	477	53.0	90.4	2.0 x 0.95 x 1.46	2,700	3.02 x 1.2 x 1.85	4,000
SGE-24SL		Natural gas	436	38.5	666	55.1	93.6	2.61 x 0.95 x 1.46	3,500	3.66 x 1.27 x 1.91	4,940
SGE-36SL		Natural gas	676	37.7	953	53.1	90.8	2.64 x 1.37 x 1.74	4,200	3.83 x 1.66 x 2.13	7,230
SGE-48SL		Natural gas	874	36.1	1,340	55.4	91.5	3.14 x 1.37 x 1.74	5,450	4.4 x 1.66 x 2.18	9,225
SGE-56SL		Natural gas	1,030	39.0	1,534	54.5	93.5	3.0 x 1.55 x 2.2	5,800	4.67 x 1.66 x 2.18	10,000

We power the world with innovative gas engines

Engine Model	Speed (rpm)	Fuel type	Electrical Power (kW)	Electrical Eff. (%)	Thermal Power (kW)	Thermal Eff. (%)	Global Eff. (%)	Engine Dimensions [L x W x H] (m)	Engine Dry Weight (kg)	Genset Dimensions [L x W x H] (m)	Genset Dry Weight [kg]
SGE-18SL	1,200	Biogas	241	38.4	322	51.4	89.8	2.0 x 0.95 x 1.46	2,700	3.02 x 1.2 x 1.85	4,000
SGE-24SL		Biogas	322	36.0	486	54.5	90.5	2.61 x 0.95 x 1.46	3,500	3.66 x 1.27 x 1.91	4,940
SGE-36SL		Biogas	484	38.3	663	52.4	90.7	2.64 x 1.37 x 1.74	4,200	3.83 x 1.66 x 2.13	7,230
SGE-48SL		Biogas	648	36.3	982	55.0	91.3	3.14 x 1.37 x 1.74	5,450	4.4 x 1.66 x 2.18	9,225
SGE-56SL		Biogas	762	38.6	1,026	52.0	90.6	3.0 x 1.55 x 2.2	5,800	4.67 x 1.66 x 2.18	10,000
SGE-18SL	1,500	Biogas	303	39.0	398	51.0	90.0	2.0 x 0.95 x 1.46	2,700	3.02 x 1.2 x 1.85	4,000
SGE-24SL		Biogas	404	38.4	546	51.8	90.2	2.61 x 0.95 x 1.46	3,500	3.66 x 1.27 x 1.91	4,940
SGE-36SL		Biogas	610	38.9	810	51.6	90.5	2.64 x 1.37 x 1.74	4,200	3.83 x 1.66 x 2.13	7,230
SGE-48SL		Biogas	811	38.7	1,097	52.2	90.9	3.14 x 1.37 x 1.74	5,450	4.4 x 1.66 x 2.18	9,225
SGE-56SL		Biogas	954	38.9	1,287	52.2	91.1	3.0 x 1.55 x 2.2	5,800	4.67 x 1.66 x 2.18	10,000
SGE-18SL	1,800	Biogas	336	37.2	480	53.1	90.3	2.0 x 0.95 x 1.46	2,700	3.02 x 1.2 x 1.85	4,000
SGE-24SL		Biogas	436	35.9	663	54.7	90.6	2.61 x 0.95 x 1.46	3,500	3.66 x 1.27 x 1.91	4,940
SGE-36SL		Biogas	676	37.6	955	53.1	90.7	2.64 x 1.37 x 1.74	4,200	3.83 x 1.66 x 2.13	7,230
SGE-48SL		Biogas	874	36.0	1,345	55.4	91.4	3.14 x 1.37 x 1.74	5,450	4.4 x 1.66 x 2.18	9,225
SGE-56SL		Biogas	1,030	36.4	1,540	54.6	91.0	3.0 x 1.55 x 2.2	5,800	4.67 x 1.66 x 2.18	10,000



## Performance data overview

Engine Model	Speed (rpm)	Fuel type	Electrical Power (kW)	Electrical Eff. (%)	Thermal Power (kW)	Thermal Eff. (%)	Global Eff. (%)	Engine Dimensions [L x W x H] (m)	Engine Dry Weight (kg)	Genset Dimensions [L x W x H] (m)	Genset Dry Weight [kg]
SGE-56SM	1,500	Natural gas	1,025	39.7	1,319	51.0	90.7	3.0 x 1.55 x 2.2	5,800	4.67 x 1.66 x 2.18	10,000
	1,800	Natural gas	1,063	37.9	1,486	52.9	90.8				
	1,500	Biogas	1,025	39.4	1,330	51.1	90.5				
	1,800	Biogas	1,063	37.8	1,494	52.9	90.7				
SGE-18SR		Natural gas	268	32.4	498	60.1	92.5	2.55 x 1.19 x 2.30	2,750	2.67 x 1.36 x 2.43	4,100
SGE-24SR		Natural gas	361	31.6	698	61.2	92.8	2.99 x 1.23 x 2.58	3,500	3.00 x 1.38 x 2.79	5,200
SGE-36SR	1,800	Natural gas	539	32.5	1,000	60.3	92.8	2.91 x 1.61 x 3.35	4,500	3.18 x 1.75 x 3.50	7,750
SGE-48SR		Natural gas	724	31.8	1,403	61.5	93.3	3.42 x 1.61 x 3.75	5,400	4.26 x 1.75 x 3.91	9,250
SGE-56SR		Natural gas	839	33.2	1,518	60.1	93.3	3.42 x 1.52 x 4.03	5,600	4.26 x 1.75 x 3.91	9,300
SGE-56HM	1,200	Natural gas	1,011	42.5	1,120	47.1	89.6	4.04 x 2.14 x 2.22	7,500	5.54 x 2.14 x 2.32	12,200
SGE-24HM		Natural gas	501	42.7	564	48.0	90.7	3.22 x 2.08 x 1.59	4,200	3.95 x 2.08 x 1.74	6,230
SGE-42HM	1,500	Natural gas	1,011	43.0	1,090	46.4	89.4	3.57 x 2.15 x 2.37	6,250	4.86 x 2.15 x 2.37	10,735
SGE-56HM		Natural gas	1,315	43.4	1,400	46.2	89.6	4.04 x 2.14 x 2.22	7,500	5.54 x 2.14 x 2.32	12,200
SGE-24HM		Natural gas	499	40.5	599	48.5	89.0	3.22 x 2.08 x 1.59	4,200	3.95 x 2.08 x 1.74	6,230
SGE-42HM	1,800	Natural gas	1,007	41.1	1,184	48.4	89.5	3.57 x 2.15 x 2.37	6,250	4.86 x 2.15 x 2.37	10,735
SGE-56HM		Natural gas	1,305	41.3	1,534	48.4	89.7	4.04 x 2.14 x 2.22	7,500	5.54 x 2.14 x 2.32	12,200

We power the world with innovative gas engines

Engine Model	Speed (rpm)	Fuel type	Electrical Power (kW)	Electrical Eff. (%)	Thermal Power (kW)	Thermal Eff. (%)	Global Eff. (%)	Engine Dimensions [L x W x H] (m)	Engine Dry Weight (kg)	Genset Dimensions [L x W x H] (m)	Genset Dry Weight [kg]
SGE - 56HM	1,200	Biogas	1,011	42.2	1132	47,3	89.5	4.04 x 2.14 x 2.22	7,500	5.54 x 2.14 x 2.32	12,200
SGE-24HM		Biogas	501	42.5	567	48.1	90.6	3.22 x 2.08 x 1.59	4,200	3.95 x 2.08 x 1.74	6,230
SGE-42HM	1500	Biogas	1,011	42.8	1,101	46.6	89.4	3.57 x 2.15 x 2.37	6,250	4.86 x 2.15 x 2.37	10,735
SGE-56HM		Biogas	1,315	43.1	1,412	46.3	89.4	4.04 x 2.14 x 2.22	7,500	5.54 x 2.14 x 2.32	12,200
SGE-24HM		Biogas	499	40.2	604	48.6	88.8	3.22 x 2.08 x 1.59	4,200	3.95 x 2.08 x 1.74	6,230
SGE-42HM	1,800	Biogas	1,007	41.0	1,190	48.5	89.5	3.57 x 2.15 x 2.37	6,250	4.86 x 2.15 x 2.37	10,735
SGE-56HM		Biogas	1,305	41.1	1,547	48.6	89.7	4.04 x 2.14 x 2.22	7,500	5.54 x 2.14 x 2.32	12,200
SGE-86EM	1,500	Natural gas	2,013	45.5	2,085	47.1	92.6	6.56 x 2.43 x 2.75	15,500	6.56 x 2.43 x 2.75	25,000
SGE-100EM	1,200	Natural gas	2,007	45.3	2,057	46.5	91.8	6.56 x 2.43 x 2.75	15,500	6.56 x 2.43 x 2.75	25,000

#### Notes

- (1) For S Series: Natural Gas MN>75 and Biogas: 62,5% CH<sub>4</sub>, 36% CO<sub>2</sub> and 1,5% N<sub>2</sub>. For other type of gases, please contact Engines.
- (2) For H and E Series: Natural Gas MN>80 and Biogas 67% CH<sub>4</sub> and 33% CO<sub>2</sub> (only for H Series).
- (3) Thermal efficiency of the S Series engines calculated considering the exhaust gases heat recovery until 120°C.
- (4) Thermal efficiency of the E Series engines calculated considering the exhaust gases heat recovery until 80°C.
- (5) Emissions level for SR Series: 0,1 g/bHPH.
- (6) SR dimensions including catalyzer.

#### Remarks

- Engine performance data acc. to ISO 3046/1, 25°C and 500 meters above sea level, with a tolerance of +5%.
- Emissions level: NO<sub>x</sub> < 500 mg/Nm<sup>3</sup> (50 Hz) and 1 g/bHPH (60Hz).
- Lower emission engines are available. Please, contact for performance data.
- Electrical power at power factor = 1.400 V (50Hz) and 480 V(60 Hz).
  - The dimensions and weights are approximate values and are subject to changes without prior notice.
  - The values given in this data sheet are for information purposes only and not binding.



**Published by**  
**Guascor Energy S.A.U.**

Oikia, 44  
20759 Zumaia (Gipuzkoa) Spain  
PO Box 30  
Tel: (Int'l +34) 943 86 52 00  
Fax: (Int'l +34) 943 86 52 10

<https://www.guascor-energy.com>

Subject to changes and errors. The information given in this document only contains general descriptions and/or performance features which may not always specifically reflect those described, or which may undergo modification in the course of further development of the products. The requested performance features are binding only when they are expressly agreed upon in the concluded contract.

© Guascor Energy 2021